

FAX NO.  
(904) 641-1697

# Coastal Industries Inc.

P.O BOX 16091  
JACKSONVILLE, FLORIDA 32245

TELEPHONE NO.  
(904) 642-3970

## Paragon 3/16" Frameless Shower Door

( exploded view )

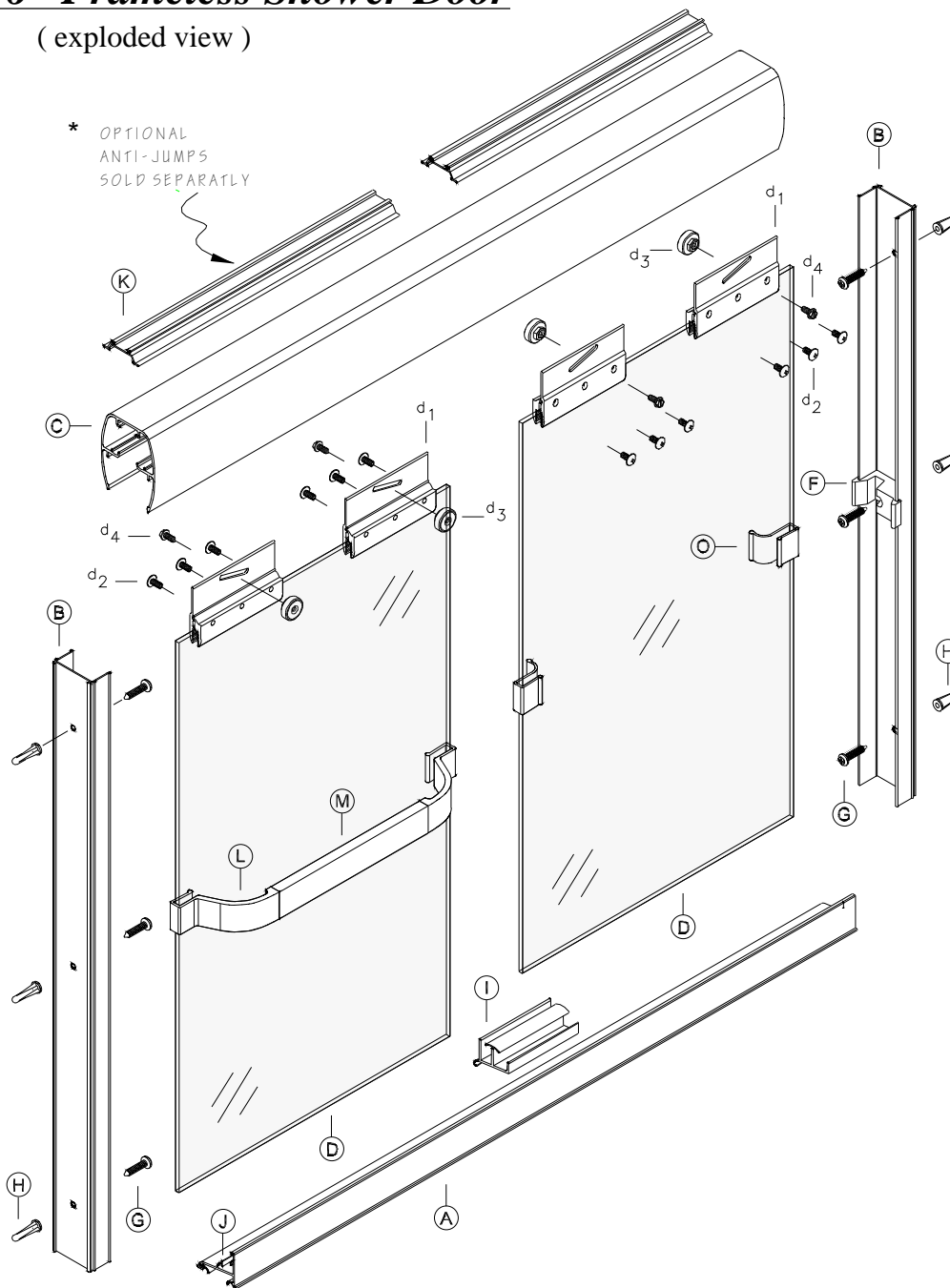

KEY LETTER	PART NUMBER	DESCRIPTION	QTY
A	492	SILL .....	1
B	126	WALL JAMB .....	1
C	938	HEADER .....	1
D	---	GLASS PANEL ASSEMBLY.....	2
d1	282 / 283	Hanger Bracket (installed).....	2
d2	1012BHP	Hanger Bracket Screws (installed) .....	6
d3	PN193	Nylon Roller (installed) .....	2
d4	832HEX	Roller Screws (installed) .....	2

KEY LETTER	PART NUMBER	DESCRIPTION	QTY
E	---	(not used) .....	---
F	5170	JAMB BUMPER .....	2
G	834Q	INSTALLATION SCREWS .....	6
H	1329	PLASTIC SCREW ANCHOR .....	6
I	C493B	TRACK GUIDE .....	1
J	C494B	SILL SEAL VINYL .....	1
K	* 130	ANTI - JUMP (optional) .....	2
L	936	TOWEL BAR BRACKETS .....	2
M	21	TOWEL BAR .....	1
N	----	(designation not used) .....	---
O	937	DOOR PULLS .....	2
P	C964B	VINYL (door pulls and towel bar brackets)..	4

1. Measure the base opening along center of shower curb as shown in figure 1, then trim Sill (A) to 3/16" less than measurement obtained.

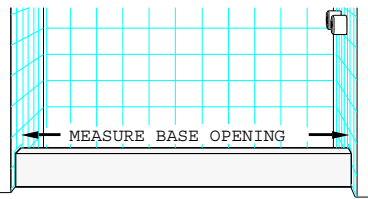

figure 1

2. Slide Vinyl Seal (J) into the Sill's receiver as shown in figure 2. Run the Vinyl the full length of the Sill, then trim any excess.

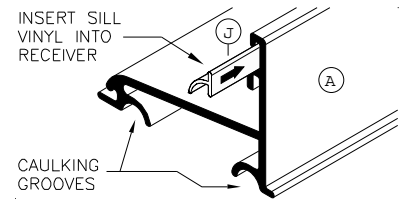

figure 2

3. To insure proper operation, Track Guide (I) must be centered on Sill (A) when installed. Located center of Sill. Apply small dab of caulking to underside of Track Guide, then snap Track Guide onto Sill as shown in figure 3.

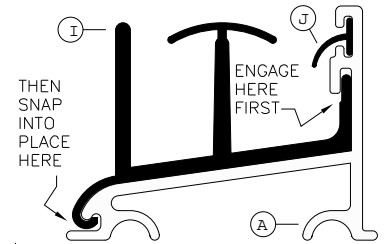

figure 3

4. Turn the Sill over and apply a bead of caulking the full length of the caulking grooves, see figure 2. With high lip toward exterior of enclosure, position Sill at center of shower curb. Temporarily tape Sill to shower curb to prevent movement.

5. Place Wall Jamb (B) on to ends of Sill (A) and up against shower walls as shown in figure 4. Plumb the Jamb, then pencil mark their installation holes locations on the shower walls (3 per jamb). Remove Wall Jamb. Using a 3/16" masonry bit, drill 1" deep installation holes in locations previously marked. Insert Plastic Screw Anchors (H) into holes.

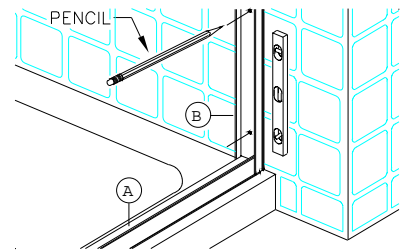

figure 4

6. Reposition Wall Jamb (B) as before. Using the top and bottom installation holes only . . . secure Jamb to walls using two(2) 834Q Installation Screws (G). Do not secure Jamb at center at this time.

7. Measure the wall to wall opening at top of Wall Jamb and cut the Header (C) to 1/16" less than the measurement obtained. If model purchased comes with Anti - Jumps (K) . . . insert Anti - Jumps (K) into the Header's Anti -Jump receiver. Position and install the Header over the Wall Jamb.

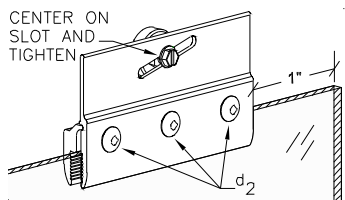

figure 5

Note:  
If you are furnishing your own glass panel for this unit . . . proceed to step 8, now. If the glass panels came with the unit you purchased, then the bracket assemblies (d1 thru d4) in the parts table are already installed. Center your Nylon Rollers (d3) on the Hanger Brackets and tighten down on the Rollers Screws (d4) as shown in figure 5 and proceed to step 9, now.

8. Using Bracket Screws (d2), loosely assemble the two piece Hanger Bracket Assemblies (d1). Do not install rollers at this time. Position brackets over glass edges as shown in exploded view - sheet 1 and figure 5 on this sheet. Position the Hanger Brackets an inch from vertical edge of glass as shown and tighten down on the screws (allen wrench required). Next install the rollers as shown and tighten down on screw.

9. Install the Towel Bar (M) on the outside panel as shown in the exploded view - sheet 1 (note that the Towel Bar is on the same side as the Nylon Rollers) . Begin by wrapping Vinyl (P) over glass edge as shown in figure 7. Use a block of wood or a rubber mallet to tap Towel Bar Brackets (L) over Vinyl (P) until seated. Position Towel Bar (M) as shown and secure with four(4) 638 Screws (N).

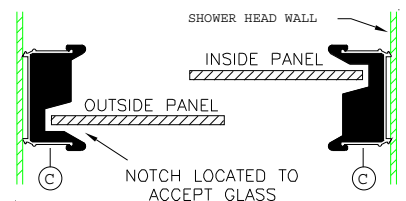

figure 6

Install remaining Vinyls (P) and the Door Pulls (O) onto the inside panel as shown in exploded view - sheet 1. Note that main handle of Door Pulls face toward inside of the enclosure so as to allow panels to "bypass" each other.

10. Install the outside Glass Panel (D) by lifting the Panel up and into the Header (B). Lower the Panel into the Track Guide (I) and engage the Rollers (d3) with the roller track.

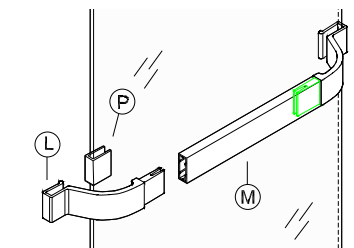

figure 7

Slide outside Door Panel into Wall Jamb located on wall opposite of shower head. Check Panel to make sure that it is parallel to the Wall Jamb. If it is not, remove the Door Panel and adjust the rollers either up or down by loosening the Rollers Screws and sliding the Rollers. When satisfied with outside Door Panel alignment, proceed with inside Door Panel installation.

When satisfied, slide inside Door Panel into Wall Jamb located on **shower head wall** and check for alignment with Wall Jamb. Adjust Rollers as necessary.

11. Attach Panel Bumpers (F) to Wall Jamb using a 834Q Installation Screw (G). Please note that notches on bumpers are positioned so as to accept glass insertion, see figure 6.

12. Run a bead of clear mildew resistant caulking down the full length of each Wall Jamb **outside** where the Jamb meet the Walls. Now run a bead **outside** where the Sill meets the curb. Follow caulking manufacturer's instructions before using shower (normally 24 hours). Installation is now complete.